

Overview

The CT7601 serial chip is a high performance USB audio bridge. It supports the DSD I/F and DoP on S/PDIF input/output channels. The I2C software control mode is available on this chip.

There are 2 kind of package on CT7601 serial chip: LQFP 80pin and QFN 48pin. The evaluation boards also have 2 types available for these 2 different package chips:

EVM-G-A: for LQFP 80 pin

EVM-G-B: for QFN 48 pin

CT7601_EVM-G-B is a full function audio evaluation system for QFN 48pin type package. The SPDIF, I2S, DSD/DOP, SRC, DAC and MCU control are combined on this board. This architecture is simple to verify and apply CT7601 family chip to any audio system product.

The CT7601_EVM-G-B interface:

- digital audio input port
 - USB SPDIF x 1
- digital audio output port
 - USB SPDIF output port x1
- analog audio output port
 - AUX analog output with high performance I2S DAC
- analog audio input port
 - high performance 8 channel record port

- Hardware control mode
 - Power on latch configuration
- Software control
 - External I2C control path to access CT7601 directly
 - Internal 8051 MCU with GPIO/I2C control

Block Diagram

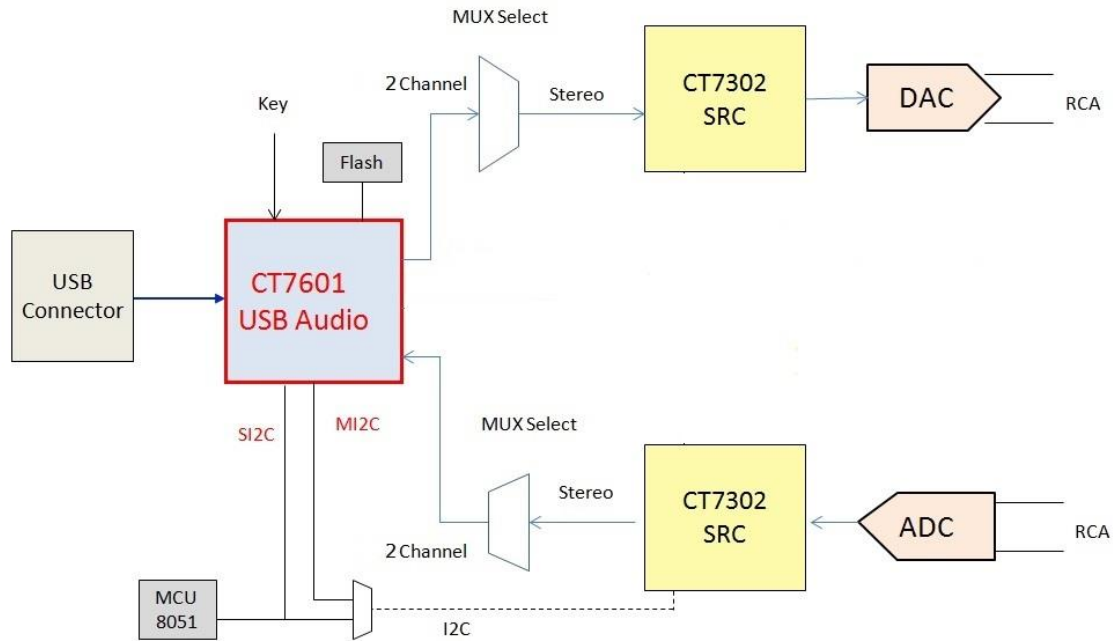

Figure1. Block diagram

PCB Overview

EVM-G-B for QFN 48 pin

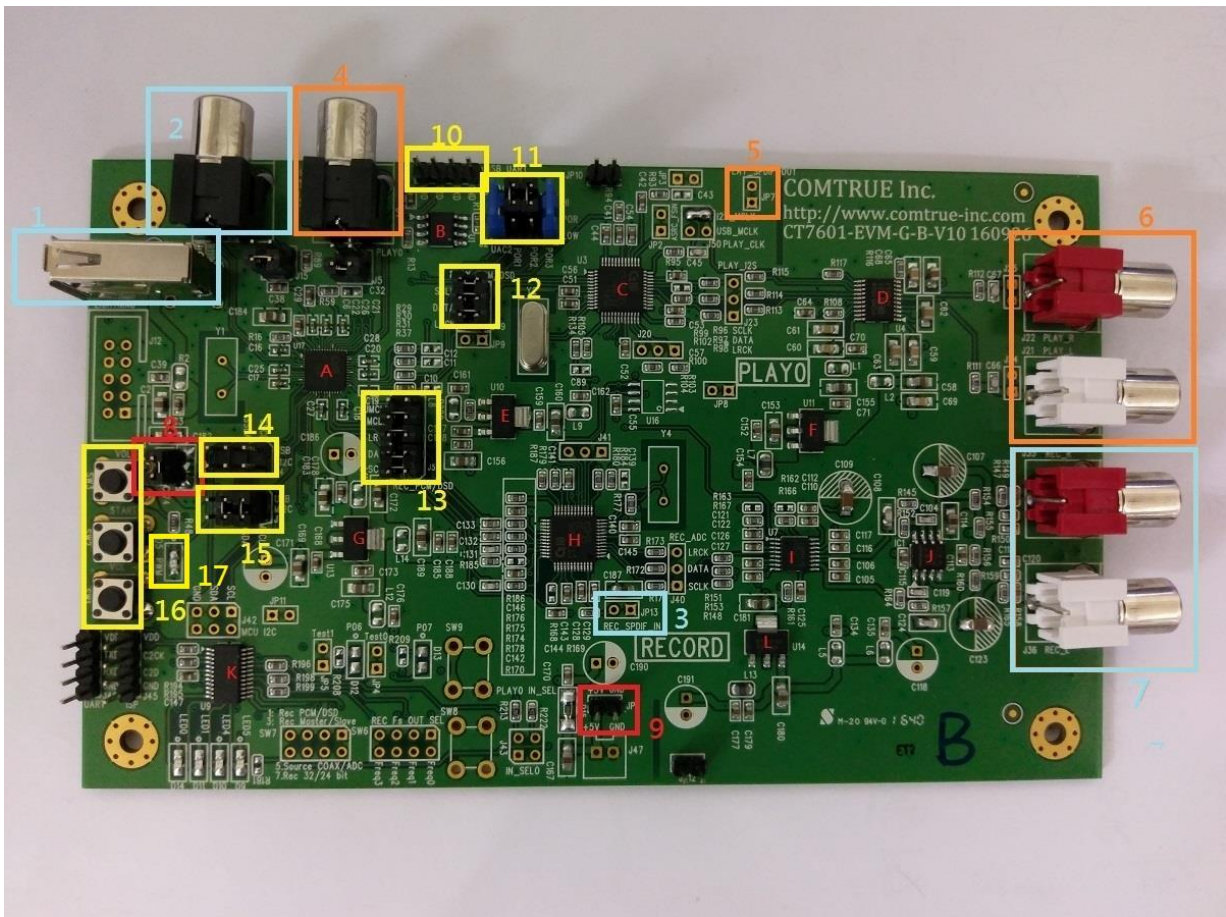

Figure2. PCB Overview

INPUT PORT		
No	Function	Description
1	USB connector	Connect to USB host port
2	USB SPDIF IN	USB SPDIF IN
3	Record SPDIF IN	Record SPDIF input solder pad
7	Record analog input	Record analog input
OUTPUT PORT		
No	Function	Description
4	USB SPDIF output	USB SPDIF output
5	SRC SPDIF output	CT7302(U3) SPDIF output solder pad
6	Play analog output	Play analog output
POWER PORT		
No	Function	Description
8	USB bus power jump	Use USB bus power to demo board when jump short it
9	Self power jump	Provide external +5V power to demo board
JUMP SETTING		
No	Function	Description
10	USB UART control port	USB UART control port
11	USB mode select pin	It have 3 different mode can choose 1:UAC2 mode(default use) 2:UAC1 mode 3:firmware update mode
12	Playback Audio Data	Playback audio data jump, default is short
13	Record Audio Daya	Record audio data jump, default is short
14	Slave I2C	I2C control select
15	Master I2C	I2C control select (default use)
16	Control button	HID button control (support VOL+/VOL-/Playback)
17	PWM LED	Default : Breathing light mode Play Music : Rhythm light mode
Chipset		
No	Part Number	Description
A	CT7601(U17)	USB2.0 Audio bridge
B	W25X20CL(U1)	SPI Flash
C	CT7302(U3)	SRC for Playback use
D	PCM5100(U4)	DAC
E	A6250K3-12A(U10)	1.2V LDO for CT7601 use

F	AP1117-3.3V(U11)	3.3V LDO for DAC use
G	AP1117-3.3V(U13)	3.3V LDO for CT7601 use
H	CT7302(U8)	SRC for Record use
I	CS5340(U7)	ADC
J	NE5532(IC1)	Amplifiers
K	EFM8BB2	MCU(not use now)
L	AP1117-3.3V(U14)	3.3V LDO for ADC use

Quickly Start

Playback Connection Diagram

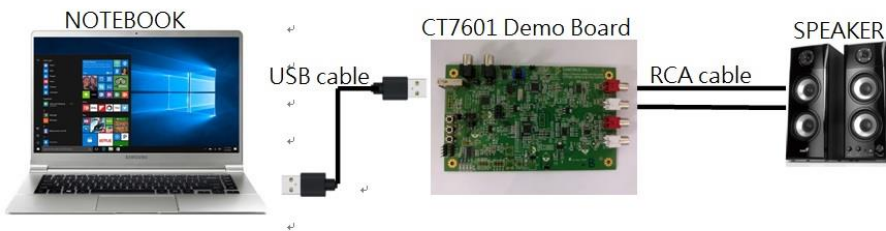

This EVM board is ready for use immediately. User can follow the procedure to set up the evaluation system for test.

1. Connect USB A-TYPE cable to EVM board's USB port and another side USB cable connect to windows / MAC or Linux USB port.
2. Download and Install ct7601_setup.exe as below link
<https://www.comtrue-inc.com/index.php/download2/category/4-ct7601>
3. Check Device Manager. Under "Sound, video and game controllers", it will have new device "Comtrue-inc UAC2 22" like below picture.

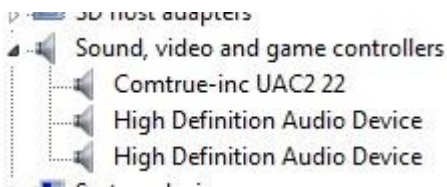

4. If you use win7 and can't install driver, please install Microsoft hotfixed as below link
<https://www.microsoft.com/en-us/download/details.aspx?id=46148>
5. The EVM board's driver have two play music mode. One is WDM mode another one is ASIO mode. For WDM mode it can use Microsoft Media Player to play it. The maximum support PCM 384K/32bit. For ASIO mode need use third party software to play it. We suggest use foobar2000 to play it. Please see how to install foobar2000 as below.
6. Download latest stable version and Install foobar2000 to play ASIO driver. <http://www.foobar2000.org/download>
7. Download and install ASIO support 2.1.2 component for foobar2000
http://www.foobar2000.org/components/view/foo_out_asio
8. Download and install foo_input_sacd component for foobar2000
https://sourceforge.net/projects/sacddecoder/files/foo_input_sacd/
9. Download and install ASIO proxy https://sourceforge.net/projects/sacddecoder/files/foo_dsd_asio/
10. Connect analog output to your speaker.
11. Start play music and enjoy it

Record Connection Diagram

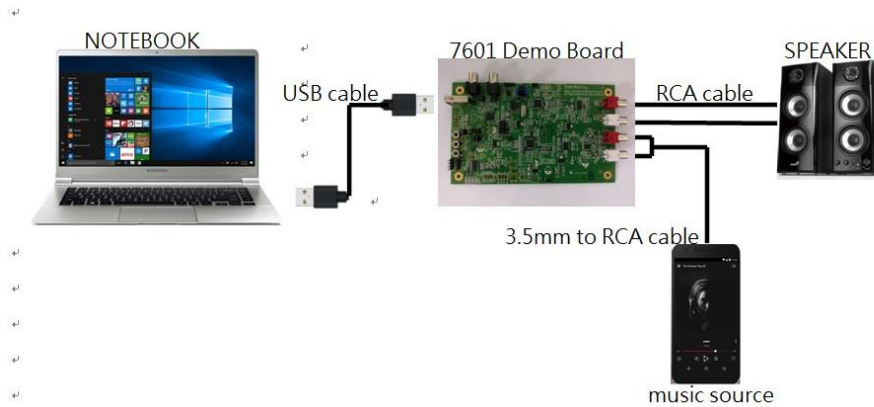

1. Connect USB A-TYPE cable to EVM board's USB port and another side USB cable connect to windows / MAC or Linux USB port.
2. Connect music source to EVM board's like DVD player , media player , mobile phone...
3. Connect analog output to your speaker if you want to listen it.
4. Use Microsoft default tool "Sound Recorder" or other recorder software to record file
5. Start record music and enjoy it

How to setup foobar2000

- Go to file/Preferences/Components Check external component install success, the will add new component like as below picture

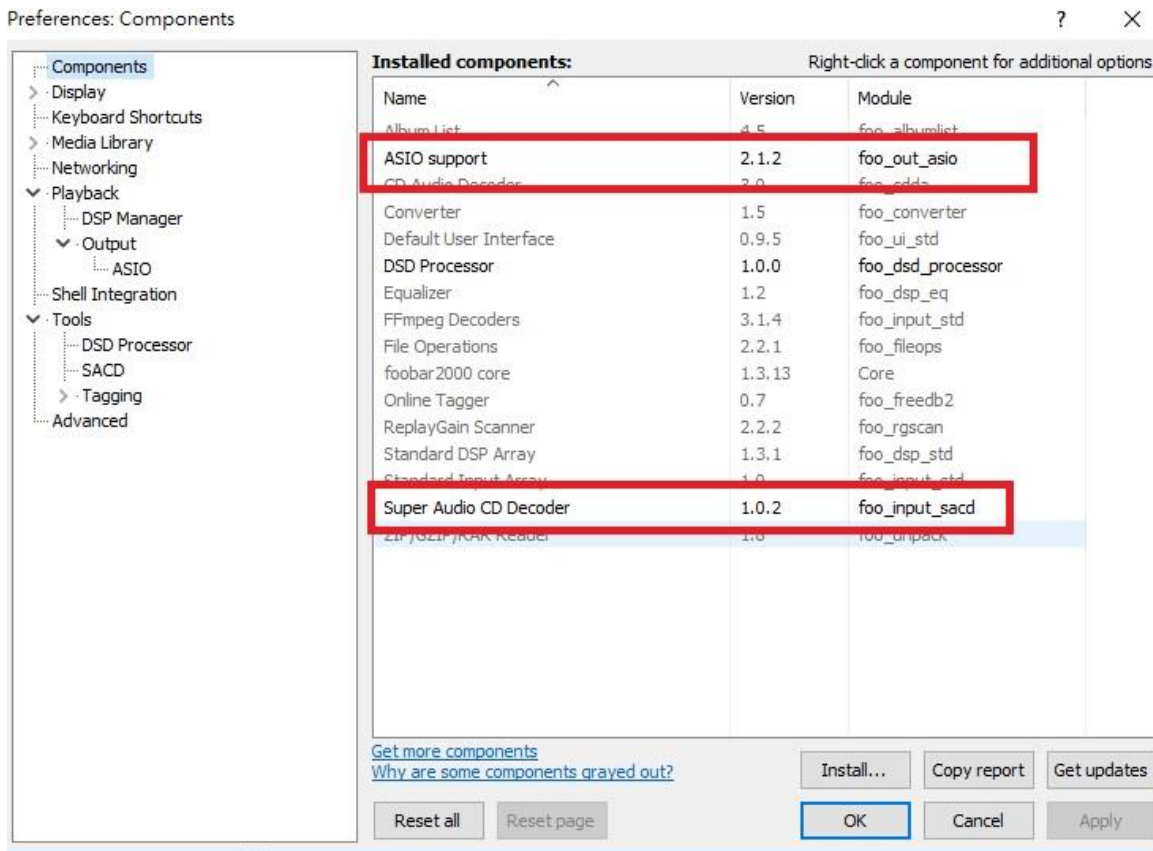

- Go to file/Preferences/Playback/Output, please choose DSD:ASIO:foo_dsd_asio



3 Go to file/Preferences/Playback/Output/ASIO, double click foo_dsd_asio and choose" ASIO Comtrue-inc UAC2 22"

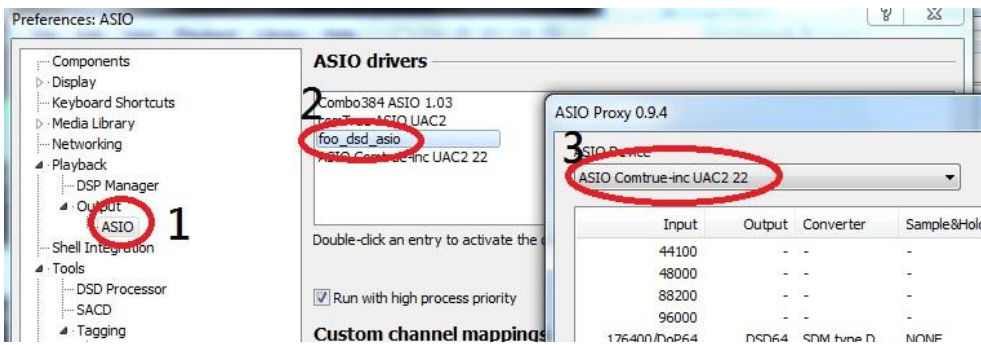

4 Go to file/Preferences/Tools/SACD, Output Mode please choose DSD

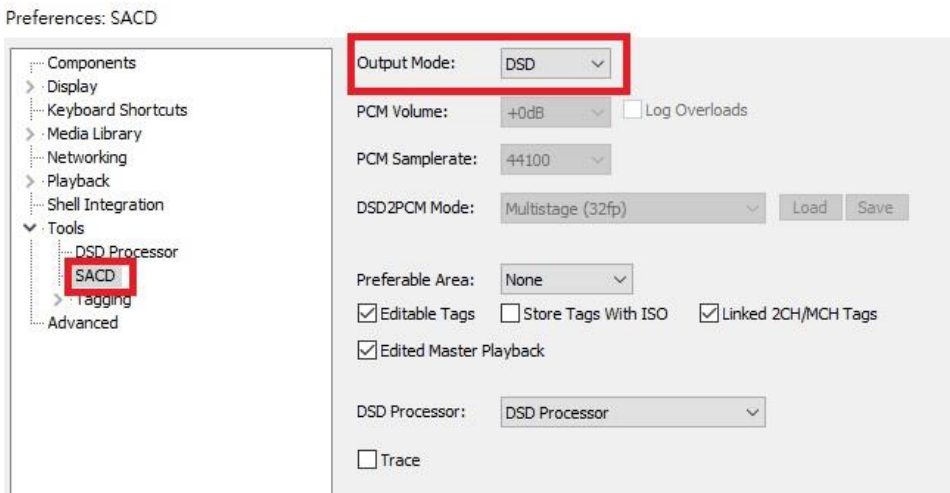

5. Choose music and you can play it now.

HID Button

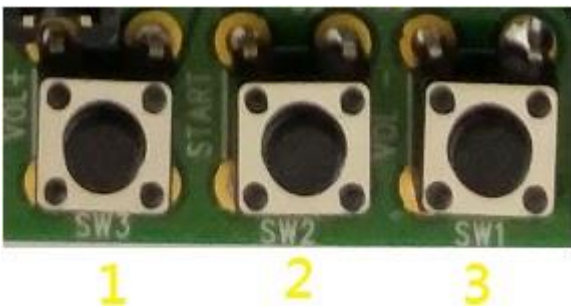

NO.	NAME	FUNCTION
1	VOL+(SW3)	Volume +
2	START(SW2)	Playback/Pause
3	VOL-(SW1)	Volume -

I2C Function



NAME	Description
SI2C(J4)	Slave I2C mode, use external I2C to control CT7601 and others chipset
MI2C(J7)	Master I2C mode, CT7601 use internal 8051 control others chipset

How to use SPDIF record

1. Plug-in SPDIF output source to EVM board record SPDIF input(J14)
2. Click mouse right button, change “Digital Input” to set as Default Device.



3. Check J15 jump is correct like below picture.



4. Use record software like windows built in software “Sound Recorder” start to record.

How to use I2S PCM/DSD directly output

1. It can use CT7601 I2S PCM/DSD output function (J49) jump to your system I2S PCM/DSD input.

NO.	NAME
1	SCLK
2	DATA
3	LRCK



2. It can use CT7302 I2S PCM output function (J23) jump to your system I2S PCM input.

NO.	NAME
1	SCLK
2	DATA
3	LRCK



MAC Play mode setup

1. MAC use UAC2 standard driver, so demo board don't need install driver. Please directly plug demo board to MAC USB port.
2. Use Spotlight to search "Midi" and use it to select Play mode. Primary Play Interface=> Play0 mode
3. The MIDI also can select audio format and channels. The audio format maximum can support to 768K/32bit.

